



Read this document carefully before using this device. The guarantee will be expired by device damages if you don't attend to the directions in the user manual. Also we don't accept any compensations for personal injury, material damage or capital disadvantages.

ENDA EPV742 PROGRAMMABLE AC/DC VOLTMETER

Thank you for choosing ENDA EPV742 Programmable AC/DC voltmeter.

- ▶ 72 x 72 mm sized
- ▶ 4 digits display
- ▶ Selectable number of decimal point
- ▶ Can be displayed between -999 and + 9999V by using voltage transformer
- ▶ Easy to use front panel keypad
- ▶ Multi-function alarm output for lower and upper limits (NO + NC)
- ▶ Multi-function alarm setpoints with alarm output (NO)
- ▶ Communication feature over isolated RS485, using ModBus RTU protocol (Optional)
- ▶ Keylock feature
- ▶ Measuring type can be selected as AC, DC or true RMS (ACDC)
- ▶ CE Marked according to European Norms.



Order Code : EPV742 -

--	--	--

1 - Supply Voltage UV.....90-250V AC LV.....10-30V DC / 8-24V AC	2 - Output R.....08A Relay	3 - Modbus RSI.....RS485 Modbus Available (Specify at order)
--	--------------------------------------	---

R^{HS}
Compliant



Technical Specifications

ENVIRONMENTAL CONDITIONS							
Ambient / Storage Temperature	0 ... +50°C/-25 ... +70°C (with no icing)						
Max. Relative Humidity	80% Relative humidity for temperatures up to 31°C, decreasing linearly to 50% at 40°C.						
Rated Pollution Degree	According to EN 60529 ; Front Panel : IP65, Rear Panel : IP20						
Height	Max. 2000m						
Do not use the device in locations subject to corrosive and flammable gases.							
ELECTRICAL CHARACTERISTICS							
Supply Voltage	90-250V AC 50/60Hz ; 10-30V DC / 8-24V AC SMPS						
Power Consumption	Max. 5VA						
Wiring	2.5mm ² screw-terminal connections						
Scale	<table border="0" style="width: 100%;"> <tr> <td style="width: 33%;">AC and RMS</td> <td>For <i>u_{trr}</i> 0...9999V, for <i>u₁₀₀</i> 0.....100V, for <i>u₅₀₀</i> 0...500V</td> </tr> <tr> <td>DC</td> <td>For <i>u_{trr}</i> -999...9999V DC, for <i>u₁₀₀</i> -100...100V DC, for <i>u₅₀₀</i> -500...+500V DC</td> </tr> </table>	AC and RMS	For <i>u_{trr}</i> 0...9999V, for <i>u₁₀₀</i> 0.....100V, for <i>u₅₀₀</i> 0...500V	DC	For <i>u_{trr}</i> -999...9999V DC, for <i>u₁₀₀</i> -100...100V DC, for <i>u₅₀₀</i> -500...+500V DC		
AC and RMS	For <i>u_{trr}</i> 0...9999V, for <i>u₁₀₀</i> 0.....100V, for <i>u₅₀₀</i> 0...500V						
DC	For <i>u_{trr}</i> -999...9999V DC, for <i>u₁₀₀</i> -100...100V DC, for <i>u₅₀₀</i> -500...+500V DC						
Sensitivity	0,01V (If, <i>u₁₀₀</i> or <i>u_{trr}</i> is selected) 0,1V (If, <i>u₅₀₀</i> is selected and higher than -100V, lower from 100V for input values) 1V (If <i>u₅₀₀</i> is selected and lower than -100V, higher from 100V for input values)						
Accuracy	<table border="0" style="width: 100%;"> <tr> <td style="width: 33%;">AC</td> <td>±%1 (Full scale) (For square wave form ± 2%)</td> </tr> <tr> <td>DC</td> <td>±%1 (Full scale)</td> </tr> <tr> <td>RMS</td> <td>±%1 (Full scale) (For square wave form ± 2%)</td> </tr> </table>	AC	±%1 (Full scale) (For square wave form ± 2%)	DC	±%1 (Full scale)	RMS	±%1 (Full scale) (For square wave form ± 2%)
AC	±%1 (Full scale) (For square wave form ± 2%)						
DC	±%1 (Full scale)						
RMS	±%1 (Full scale) (For square wave form ± 2%)						
Input Range	-500V...500V (If <i>u₅₀₀</i> is selected, device breaks down at more than ±1250 DC voltages.) -100V...100V (If <i>u_{trr}</i> or <i>u₁₀₀</i> is selected, device breaks down at more than ±250 DC voltages.)						
Input Impedance	870kΩ						
Frequency Range	DC , 10Hz - 200Hz (For square wave form 10Hz-70Hz)						
EMC	EN 61326-1: 2013						
Safety Requirements	EN 61010-1: 2010 (Pollution degree 2, overvoltage category II)						
OUTPUTS							
Output	Relay: 250V AC, 8A (for resistive load), NO						
Life Expectancy for Relay	Mechanical 30.000.000 operation; 100.000 operation at 250V AC, 2A resistive load.						
HOUSING							
Housing Type	Suitable for flush-panel mounting. (According to DIN 43 700)						
Dimensions	W72xH72xD97mm						
Weight	Approx. 350g (after packing)						
Enclosure Material	Self extinguishing plastics.						
While cleaning the device, solvents (thinner, gasoline, acid etc.) or corrosive materials must not be used.							

DIMENSIONS

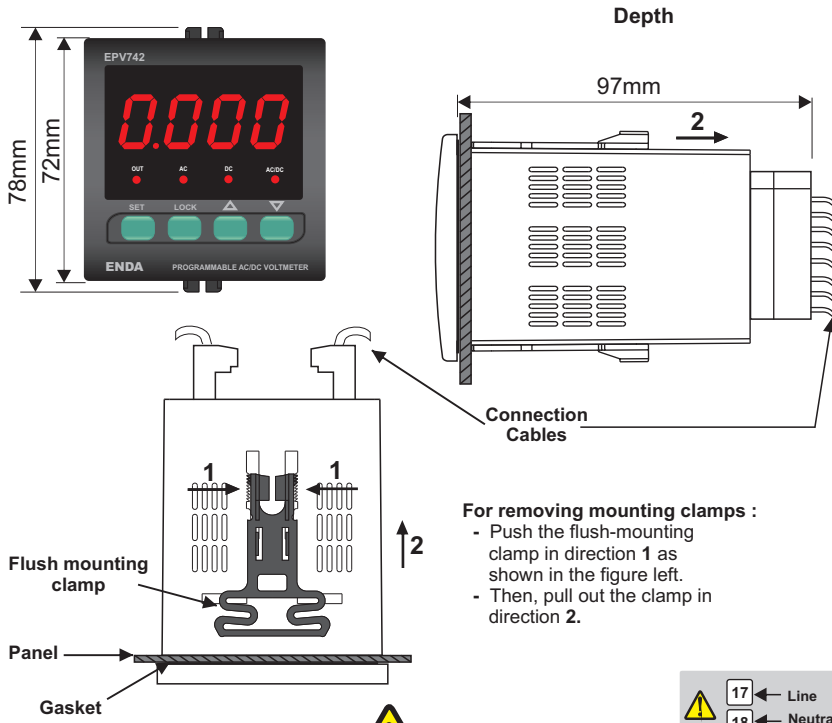

For removing mounting clamps :

- Push the flush-mounting clamp in direction 1 as shown in the figure left.
- Then, pull out the clamp in direction 2.

Note :

- 1) Panel thickness should be maximum 10mm.
- 2) There must be at least 90mm free space behind the device, otherwise it would be difficult to remove it from the panel.

CONNECTION DIAGRAM

ENDA EPV742 is intended for installation in control panels. Make sure that the device is used only for intended purpose. The electrical connections must be carried on by a qualified staff and must be according to the relevant locally applicable regulations. During an installation, all of the cables that are connected to the device must be free of electrical power. The device must be protected against inadmissible humidity, vibrations and severe soiling. Make sure that the operation temperature is not exceeded. The cables should not be close to the power cables or components.

! If *ItYP* input type "u500" is selected, the measurement terminals 13 and 16 of the terminals must be connected. Otherwise, measurement will be incorrect.

! If *ItYP* input type "u100" or *utrr* is selected, the measurement terminals 14 and 15 of the terminals must be connected. Otherwise, measurement will be incorrect.

NOTE :

SUPPLY :



! Fuse should be connected.

Cable size: 1,5mm²

- 1) Mains supply cords shall meet the requirements of IEC 60227 or IEC 60245.
- 2) In accordance with the safety regulations, the power supply switch shall bring the identification of the relevant instrument and it should be easily accessible by the operator.

Holding screw 0.4-0.5Nm.

Equipment is protected throughout by DOUBLE INSULATION

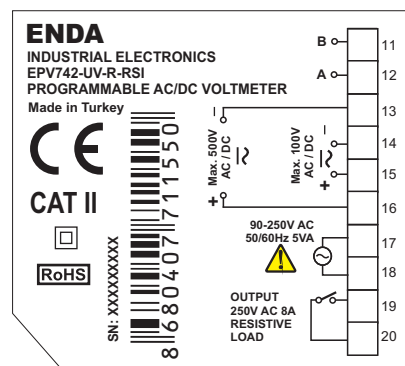
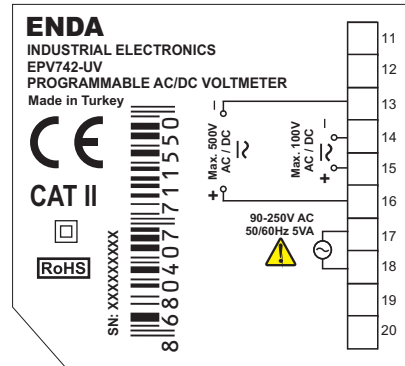
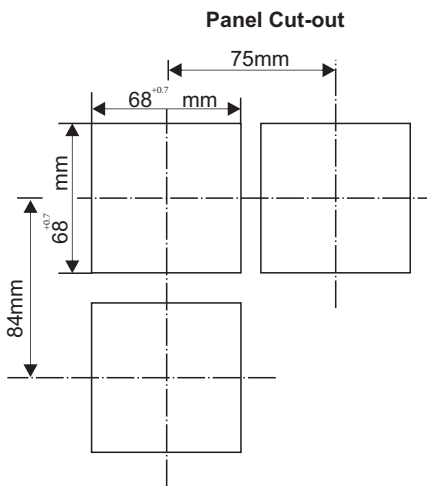

OUTPUT CHART

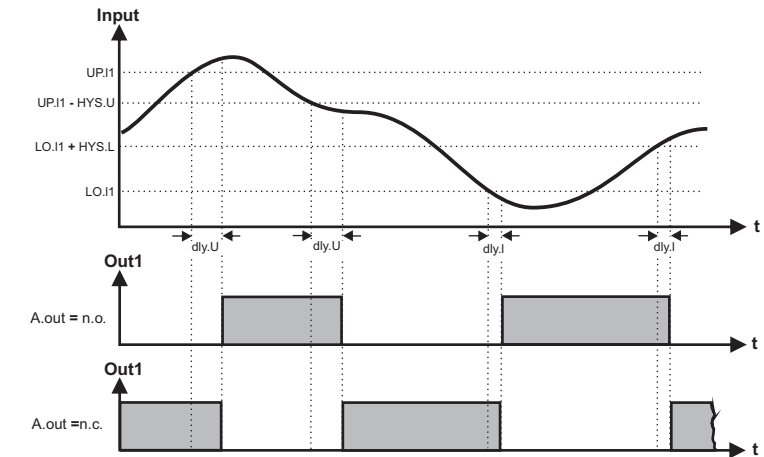

	ac	dc	Ac.dc (rms)
	$A \frac{1}{\sqrt{2}}$	0.000	$A \frac{1}{\sqrt{2}}$
	0.308 A	$A \frac{2}{\pi}$	$A \frac{1}{\sqrt{2}}$
	0.386 A	$A \frac{1}{\pi}$	$A \frac{1}{2}$
	A	0.000	A
	$A \frac{1}{2}$	$A \frac{1}{2}$	$A \frac{1}{\sqrt{2}}$
	$A \sqrt{\frac{d}{T} - \frac{d^2}{T^2}}$	$A \frac{d}{T}$	$A \sqrt{\frac{d}{T}}$
	$A \frac{1}{\sqrt{3}}$	0.000	$A \frac{1}{\sqrt{3}}$



EPV742 PROGRAMMING DIAGRAM

- Increment Key** Used for increasing the setpoint value and changing parameters. When held down for a few seconds, configured numeric value increases faster.
- Decrement Key** Used for decreasing the setpoint value and changing parameters. When held down for a few seconds, configured numeric value increases faster.
- Programming Key** Used for displaying and configuring the selected parameter value.
- Lock / Unlock Keypad** Locks / Unlocks keypad.

If these keys are pressed and held for 3 seconds, "Programming Mode" is entered or it returns to "Running Mode". If and keys are pressed while parameter names are displayed, than it returns to measured value.

PROGRAMMING MODE

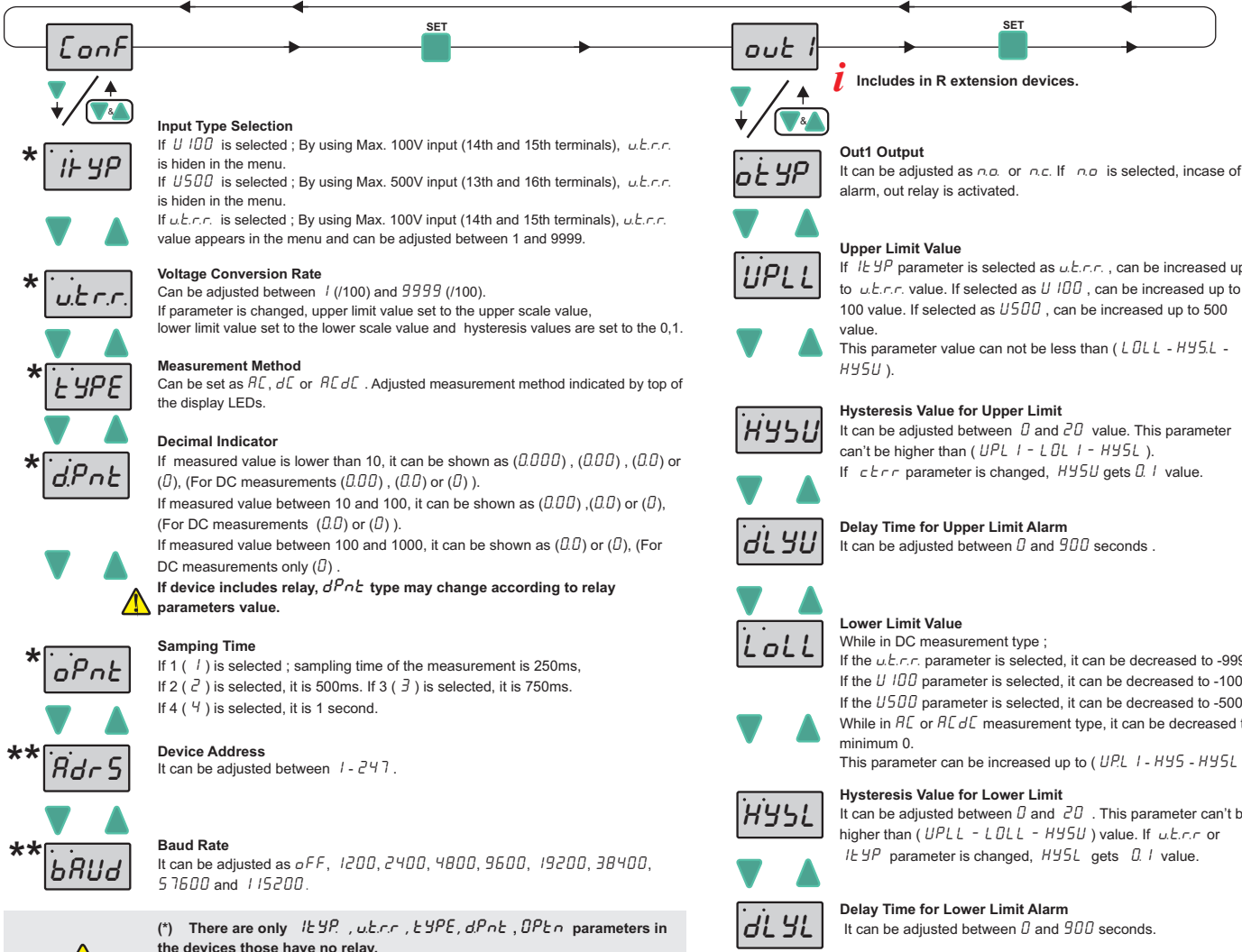

- Input Type Selection**
If *U100* is selected; By using Max. 100V input (14th and 15th terminals), *uErr* is hidden in the menu.
If *U500* is selected; By using Max. 500V input (13th and 16th terminals), *uErr* is hidden in the menu.
If *uErr* is selected; By using Max. 100V input (14th and 15th terminals), *uErr* value appears in the menu and can be adjusted between 1 and 9999.
- Voltage Conversion Rate**
Can be adjusted between *1* (100) and *9999* (100).
If parameter is changed, upper limit value set to the upper scale value, lower limit value set to the lower scale value and hysteresis values are set to the 0,1.
- Measurement Method**
Can be set as *AC*, *dc* or *ACdc*. Adjusted measurement method indicated by top of the display LEDs.
- Decimal Indicator**
If measured value is lower than 10, it can be shown as (0.000), (0.00), (0.0) or (0). (For DC measurements (0.00), (0.0) or (0)).
If measured value between 10 and 100, it can be shown as (0.00), (0.0) or (0). (For DC measurements (0.0) or (0)).
If measured value between 100 and 1000, it can be shown as (0.0) or (0). (For DC measurements only (0)).
- ! If device includes relay, dPnt type may change according to relay parameters value.**
- Sampling Time**
If 1 (1) is selected; sampling time of the measurement is 250ms,
If 2 (2) is selected, it is 500ms. If 3 (3) is selected, it is 750ms.
If 4 (4) is selected, it is 1 second.
- Device Address**
It can be adjusted between *1* - *247*.
- Baud Rate**
It can be adjusted as *oFF*, *1200*, *2400*, *4800*, *9600*, *19200*, *38400*, *57600* and *115200*.

(*) There are only *itYP*, *uErr*, *tYPE*, *dPnt*, *oPnt* parameters in the devices those have no relay.
(**) The *AdrS* and *bAUD* parameters are only in the devices those have modbus.

SETTING UP THE PARAMETERS

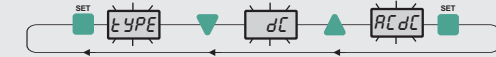

- If key is pressed, the current value of the parameter appears by flashing on the display.
- By using "UP" or "DOWN" navigation keys, selected parameter can be adjusted to the desired value.
- After the setting up the parameters, if set key is pressed again, adjusted parameter name appears on display.

LOCKING & UNLOCKING KEYPAD



QUICK MENU

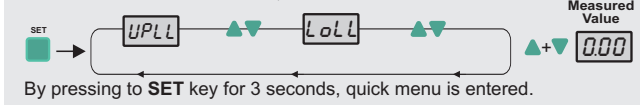

REVISION NUMBER

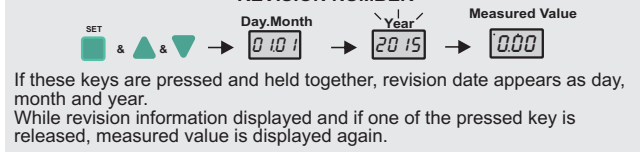

DEFAULT SETTINGS

Powered on device by pressing key *dPAr* message appears on display and device reset to default settings.

ERROR MESSAGES

- Measured current value is higher than maximum scale.
- Measured current value is lower than minimum scale.

ENDA EPV742 DIGITAL VOLTMETER MODBUS PROTOCOL ADDRESS MAP

HOLDING REGISTERS FOR R EXTENSION DEVICES

Holding Register Addresses		Data Type	Data Content	Parameter Name	Read/Write Permission	Status Value
Decimal	Hex					
0000d	0x0000	word	Alarm output status	<i>0LYP</i>	Readable/Writable	<i>no</i>
0001d	0x0001	word	Input type selection	<i>1LYP</i>	Readable/Writable	<i>u.t.r.r</i>
0002d	0x0002	word	Voltage Conversion Rate	<i>u.t.r.r</i>	Readable/Writable	<i>100</i>
0003d	0x0003	word	The upper limit of the setpoint	<i>UPLL</i>	Readable/Writable	<i>5000</i>
0004d	0x0004	word	The upper limit of the hysteresis value	<i>HYSU</i>	Readable/Writable	<i>10</i>
0005d	0x0005	word	Delay time for the upper limit alarm	<i>dLYU</i>	Readable/Writable	<i>0</i>
0006d	0x0006	word	The lower limit of the setpoint	<i>LOLL</i>	Readable/Writable	<i>00</i>
0007d	0x0007	word	The lower limit of the hysteresis value	<i>HYSL</i>	Readable/Writable	<i>10</i>
0008d	0x0008	word	Delay time for the lower limit alarm	<i>dLYL</i>	Readable/Writable	<i>0</i>
0009d	0x0009	word	Measurement method (<i>0=AC</i> , <i>1=dC</i> , <i>2=ACdC</i>)	<i>TYPE</i>	Readable/Writable	<i>ACdC</i>
0010d	0x000A	word	Decimal point. (<i>0=X</i> , <i>1=X.X</i> , <i>2=X.XX</i> , <i>3=X.XXX</i>)	<i>dPnt</i>	Readable/Writable	<i>00</i>
0011d	0x000B	word	Sampling time of the measurement value. If 1 is selected, it is 250ms. If 2 is selected, it is 500ms. If 3 is selected, it is 750ms. If 4 is selected, it is 1 second.	<i>oPtn</i>	Readable/Writable	<i>4</i>
0012d	0x000C	word	Device address for RS485 network connection. Adjustable between 1-247.	<i>Adrs</i>	Readable/Writable	<i>1</i>
0013d	0x000D	word	Baudrate (<i>0=Off</i> ; <i>1=1200</i> ; <i>2=2400</i> ; <i>3=4800</i> ; <i>4=9600</i> ; <i>5=19200</i> ; <i>6=38400</i> ; <i>7=57600</i> ; <i>8=115200</i>)	<i>bAud</i>	Readable/Writable	<i>oFF</i>

*Holding Register Parameter Table (No Relay Models)

0000d	0x0000	word	Input type selection	<i>1LYP</i>	Readable/Writable	<i>u.t.r.r</i>
0001d	0x0001	word	Voltage Conversion Rate	<i>u.t.r.r</i>	Readable/Writable	<i>100</i>
0003d	0x0003	word	Measurement method (<i>0=AC</i> , <i>1=dC</i> , <i>2=ACdC</i>)	<i>TYPE</i>	Readable/Writable	<i>ACdC</i>
0004d	0x0004	word	Decimal point. (<i>0=X.XX</i> , <i>1=X.X</i> , <i>2=X</i>)	<i>dPnt</i>	Readable/Writable	<i>0.000</i>
0005d	0x0005	word	Sampling time of the measurement value	<i>oPtn</i>	Readable/Writable	<i>4</i>
0006d	0x0006	word	Device address for RS485 network connection. Adjustable between 1-247.	<i>Adrs</i>	Readable/Writable	<i>1</i>
0007d	0x0007	word	Baudrate (<i>0=Off</i> ; <i>1=1200</i> ; <i>2=2400</i> ; <i>3=4800</i> ; <i>4=9600</i> ; <i>5=19200</i> ; <i>6=38400</i> ; <i>7=57600</i> ; <i>8=115200</i>)	<i>bAud</i>	Readable/Writable	<i>9600</i>

INPUT REGISTERS FOR EPV742-x-xxx-RSI DEVICES

Input Register Addresses		Data Type	Data Content	Parameter Name	Read/Write Permission
Decimal	Hex				
0000d	0x0000	word	Measured voltage value	--	Only Readable

DISCRETE INPUTS FOR R EXTENSION DEVICES

Discrete Input Addresses		Data Type	Data Content	Parameter Name	Read/Write Permission
Decimal	Hex				
0000d	0x0000	Bit	Relay output state (<i>0=oFF</i> ; <i>1=on</i>)	--	Only Readable

COILS FOR R EXTENSION DEVICES

Coil Addresses		Data Type	Data Content	Parameter Name	Read/Write Permission	Status Value
Decimal	Hex					
0000d	0x0000	Bit	Alarm output state (<i>0=no</i> ; <i>1=nc</i>)	<i>0LYP</i>	Readable/Writable	<i>no</i>

* Coil and Discrete input parameters are not available in the devices those have no relay

Note 1 : *0LYP* menu parameters can be used as "Holding Register" or "Coil".

Note 2 : Received "ModBus input register value" is multiplying by 1000 (based on *dPnt*) and mV value reached.

For example ;

if modbus value is 2842, (for *dPnt* = 2 (*0.00*)) $28.42 \times 1000 = 28420$ mV, ie 28.42V

if modbus value is 2842, (for *dPnt* = 3 (*0.000*)) $2.842 \times 1000 = 2842$ mV, ie 2.842V