

DIMENSIONS

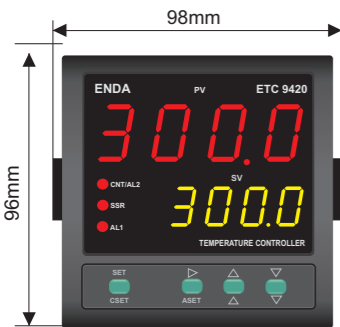

Panel cut-out:

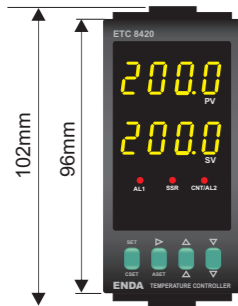
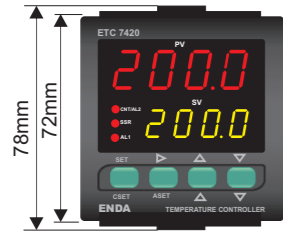
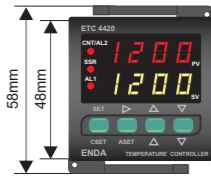
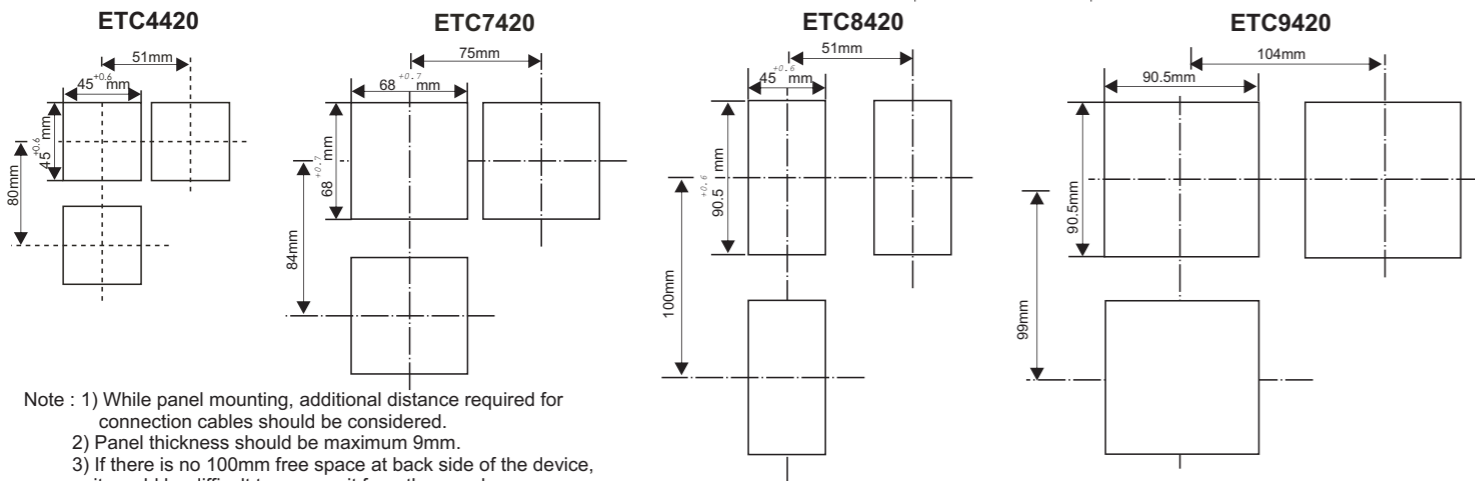

Note : 1) While panel mounting, additional distance required for connection cables should be considered.
 2) Panel thickness should be maximum 9mm.
 3) If there is no 100mm free space at back side of the device, it would be difficult to remove it from the panel.

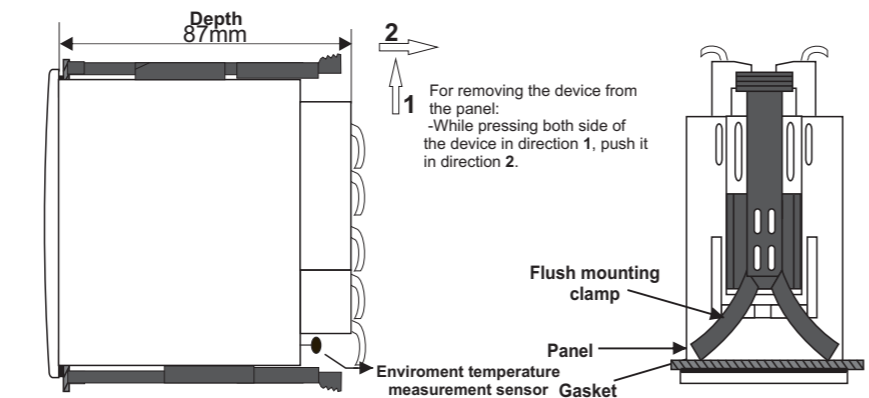
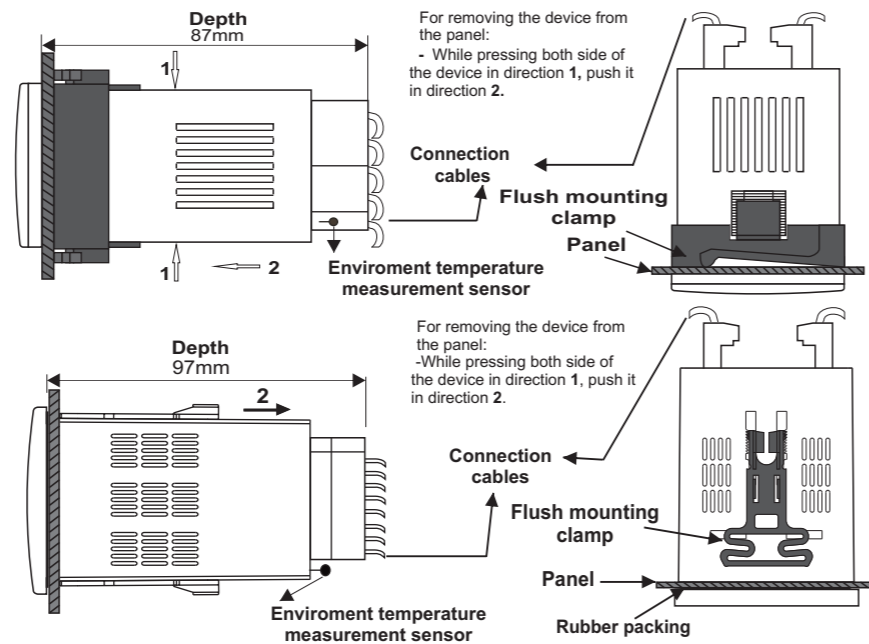

Read this document carefully before using this device. The guarantee will be expired by damaging of the device if you don't attend to the directions in the user manual. Also we don't accept any compensations for personal injury, material damage or capital disadvantages.

ENDA ETC SERIES PID TEMPERATURE CONTROLLERS

Thank you for choosing ENDA ETC SERIES temperature controllers

- * Selectable sensor type.
- * Automatic calculation of PID parameters (SELF TUNE).
 ⚠ Enter PID parameters of the system if they are known at the beginning. Otherwise, Self-Tune should be activated.
- * Soft-Start.
- * Communication via RS-485 ModBus protocol (Optional).
- * Selectable SSR or relay control output.
- * Relay output can be programmable as second alarm or control output.
- * AL1 relay output for first alarm out.
- * Selectable Heat/Cool control.
- * Input offset feature.
- * In the case of sensor failure periodical running or relay state can be selected.
- * Parameter access protection on 3 levels.
- * Programming by using keypad or Modbus.
- * CE marked according to European Norms.



RoHS Compliant



Order Code : ETC - -

- | | | |
|-----------------------|----------------------------|--|
| 1 - Dimensions | 2 - Supply Voltage | 3 - Modbus Option |
| 4420.....48x48x87mm | 230VAC...230V AC | RS.....RS-485 Modbus communication |
| 7420.....72x72x97mm | 24VAC.....24V AC | None.....Don't support RS-485 Modbus comm. |
| 8420.....48x96x87mm | SM.....9-30V DC / 7-24V AC | |
| 9420.....96x96x50mm | | |

TECHNICAL SPECIFICATIONS

Input type		Temperature range	
J (Fe-CuNi) Thermocouple	EN 60584	0... 600°C	+32... +1112°F
K (NiCr-Ni) Thermocouple	EN 60584	0...1200°C	+32... +2192°F
T (Cu-CuNi) Thermocouple	EN 60584	0... 400°C	+32... +752°F
S (Pt10Rh-Pt) Thermocouple	EN 60584	0...1600°C	+32... +2912°F
R (Pt13Rh-Pt) Thermocouple	EN 60584	0...1600°C	+32... +2912°F
Pt 100 Resistance thermometer	EN 60751	-200...600°C	-328... +1112°F
Pt 100 Resistance thermometer	EN 60751	-99.9...300.0°C	-99.9...+543.0°F

ENVIRONMENTAL CONDITIONS

Ambient/storage temperature	0 ... +50°C / -25... +70°C (with no icing)
Max. Relative humidity	80% up to 31°C decreasing linearly 50% at 40°C .
Rated population degree	According to EN 60529 Front panel : IP65 Rear panel : IP20
Height	Max. 2000m



Do not use the device in locations subject to corrosive and flammable gases.

ELECTRICAL CHARACTERISTICS

Supply	230VAC ±%10 -%20 or 24VAC ±%10, 50/60Hz or by your choose 9-30VDC / 7-24VAC ±%10 SMPS
Power consumption	Max. 7VA (For ETC4420 5VA)
Wiring	2.5mm ² screw-terminal connections
Line resistance	For thermocouple max. 100ohm, for 3 wired Pt 100 max. 20ohm
Accuracy	± 0,2% (of full scale) ±1 digit
Data retention	EEPROM (minimum 10 years)
EMC	EN 61326-1:1997, A1:1998, A2:2001 (Performance criterion B for standard EN 61000-4-3)
Safety requirements	EN 61010-1: 2001 (Pollution degree 2, overvoltage category II)

OUTPUTS

CONT./AL2	Relay : 250V AC, 2A (for resistive load), Selectable as Control or Alarm2 output.
AL1	Relay : 250V AC, 2A (for resistive load), NO/NC selectable. (Alarm1 output).
SSR out	Selectable logic control output. (Max 12V 20mA).
Life expectancy for relay	Mechanical 30.000.000 operation; Electrical 300.000 operation

CONTROL

Control type	Single set-point and alarm control
Control algorithm	On-Off / P, PI, PD, PID (selectable)
A/D converter	Better than 15 bits
Sampling time	500ms
Proportional band	Adjustable between %0 and %100. If P _b =%0, On-Off control is selected.
Integral time	Adjustable between 0.0 and 100.0 minutes.
Derivative time	Adjustable between 0.00 and 25.00 minutes.
Control period	Adjustable between 1 and 250 seconds.
Hysteresis	Adjustable between 1 and 50°C/F. If $inP=PE.D$, adjustable between 0,1 and 50°C/F)
Output power	The ratio of power at a set point can be adjusted between 0% and 100%

HOUSING

Housing type	Suitable for flush-panel mounting according to DIN 43 700.
Dimensions	ETC4420 : G48xY48xD87mm ETC7420 : G72xY72xD97mm ETC8420 : G48xY96xD87mm ETC9420 : G96xY96xD50mm
Weight	Approximately 400g after packing (For ETC4420 250g).
Enclosure material	Self extinguishing plastics.



While cleaning the device, solvents (thinner, benzene, acid etc.) or corrosive materials must not be used.

TERMS

PV Display :
 Process value during normal operation
 Mnemonic parameter code during programming

SV Display :
 Set point during normal operation
 Date value during programming

Control set key during normal operation
 Parameter selection key during programming

Alarm set key during normal operation
 Menu selection key during programming

Increment key during normal operation and programming
 Parameter selection key during programming

Decrement key during normal operation
 If only this key is pressed in normal operation, software version number is seen

PV display	7 segment, 4 digits, red LED indicator yellow LED ind.(ETC8420)
SV display	7 segment, 4 digits, yellow LED indicator
Character heights	PV display : 7mm(ETC4420) 12.5mm(ETC8420) 14mm(ETC7420) 20.3mm(ETC9420) SV display : 7mm(ETC4420) 12.5mm(ETC8420) 10.2mm(ETC7420) 14mm(ETC9420)
Keypad	Mikro Switch
State indicator	3 red LEDs for Control, Alarm1 and SSR outputs

